

HOOK SYSTEM I (SET)

Art. 45691 Hakensystem | hook system | système de crochet | haken systeem

- 1** 1 × | ART. 45685 | Feder // Spring
- 2** 1 × | ART. 46306 | Schraube // Screw | 3 × 6 mm
- 3** 2 × | ART. 45679 | Haken // Anchoring Hook
- 4** 2 × | ART. 45680 | Hakenarretierung // Hook Adjustment
- 5** 2 × | ART. 42041 | M4 | Mutter // Nut
- 6** 9 × | ART. 45675 | Kunststoffmutter // Plastic Nut
- 7** 1 × | ART. 45678 | Riegel // Bracket
- 8** 2 × | ART. 44416 | M4 × 16 mm | Schraube // Screw
- 9** 2 × | ART. 45682 | 12 mm | Hakeneinlage // Hook Inlay
- 10** 2 × | ART. 45681 | 10 mm | Hakeneinlage // Hook Inlay
- 11** 4 × | ART. 46414 | 4 × 14 mm | Schraube // Screw
- 12** 1 × | ART. 45683 | Obere Schiene // Upper Rail
- 13** 3 × | ART. 46418 | 4 × 18 mm | Schraube // Screw
- 14** 1 × | ART. 48514 | M5 × 14 mm | Schraube // Screw
- 15** 1 × | ART. 45673 | Halbellipse // Half Ellipsis
- 16** 2 × | ART. 45697 | Endstück Halbellipse // Endcap Half Ellipsis
- 17** 1 × | ART. 45671 | Klemmschieber // Clamping Slide
- 18** 1 × | ART. 45674 | Arretierungsplatte // Adjustment Plate
- 19** 1 × | ART. 45676 | Arretierungsrad // Adjustment Wheel
- 20** 1 × | ART. 41054 | M5 | Mutter // Nut
- 21** 1 × | ART. 45677 | Arretierungshaken // Adjustment Hook
- 22** 3 × | ART. 46414 | M4 × 14 mm | Schraube // Screw
- 23** 1 × | ART. 45672 | Kantenschoner // Edge Protector

Art. 987666-001
Upper Rail Set

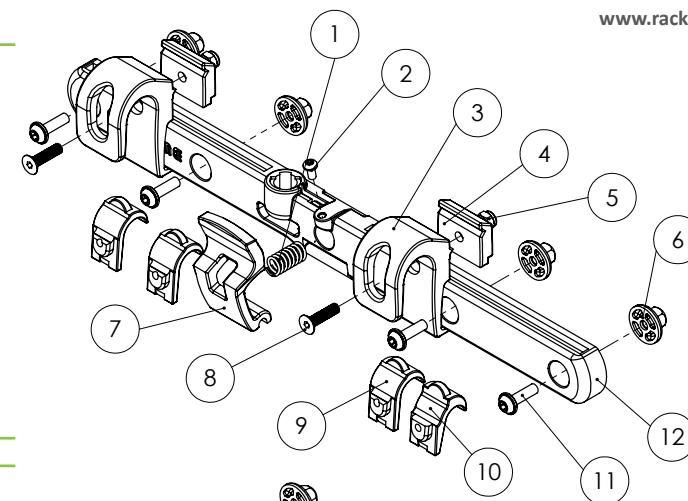

Art. 988666-001
Lower Rail Set

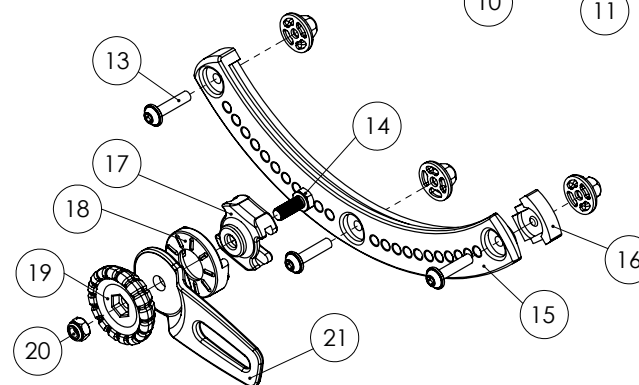

Art. 89666-001
Corner Protector Set

